



# Orlando Cushion Box

Assembly Instructions - Please keep for future reference

BDFURN2024DJL018

BDFURN2025DJ003 / BDFURN2026DJL36

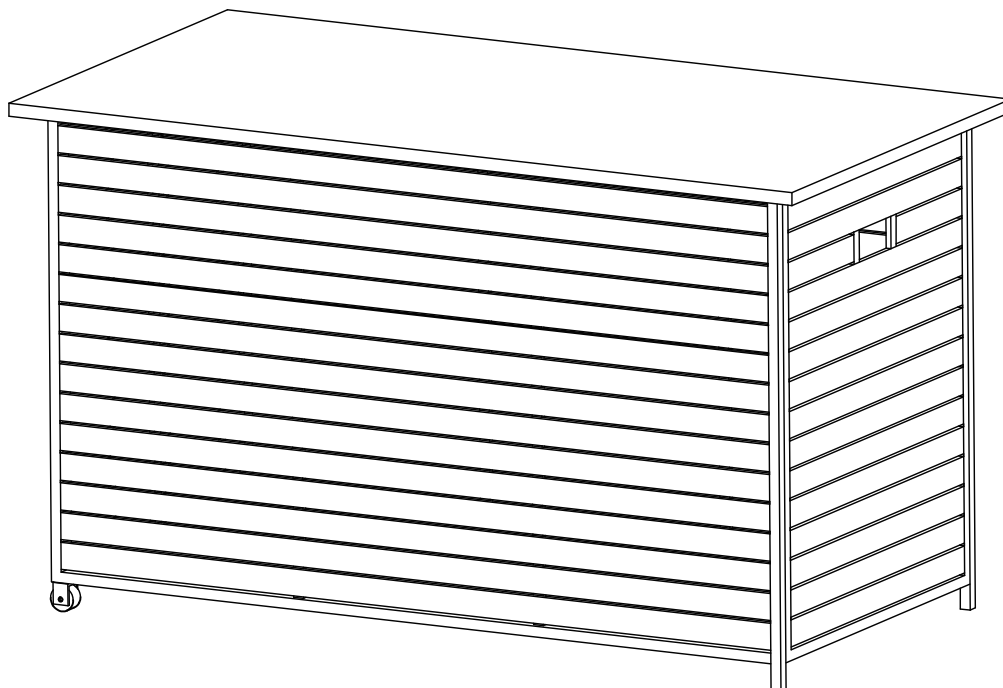

**Important:** Do not fully tighten all screws until assembly is complete.

Blue Diamond Ltd, PO BOX 350, St. Peter Port, Guernsey, GY1 3XA

Website: [www.bluediamond.gg](http://www.bluediamond.gg)

Email: [info@bluediamond.gg](mailto:info@bluediamond.gg)





# Safety and Care Advice

**Important – Please read these instructions fully before starting assembly**

- Check you have all the components and tools listed on page 2.
- Remove all fittings from the plastic bags and separate them into their groups.
- Keep children and animals away from the work area, small parts could choke if swallowed.
- Make sure you have enough space to layout the parts before starting.
- Do not stand or put weight on the parts during assembly, this could cause damage.

- Assemble on a soft level surface to avoid damaging the unit or your floor.



- We do not recommend the use of power drill/drivers for inserting screws, as this could damage the unit, only use hand screwdrivers.

- Dispose of all packing carefully and responsibly.
- Do not sit or stand on this cushion box.
- **Please lift with care.**

## Care and maintenance

- Wash glass with mild soap and water, rinse thoroughly, and dry glass completely.
- Do not use the glass as chopping surface. Do not strike the glass with hard or pointed items.
- In order to prolong the life and your table, we recommend it be stored in a dry and protected area during off season periods.
- Do not use washing powders or any abrasive substances which may scratch the surface.



## Friendly Tips

- Do not fully tighten all screws until assembly is complete.
- Make sure the assemble will be easier with 2 people.

Blue Diamond Ltd, PO BOX 350, St. Peter Port, Guernsey, GY1 3XA

Website: [www.bluediamond.gg](http://www.bluediamond.gg)











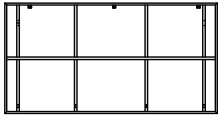

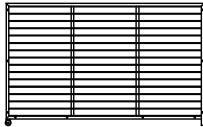

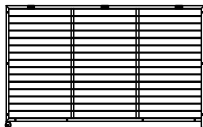
Email: [info@bluediamond.gg](mailto:info@bluediamond.gg)

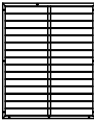

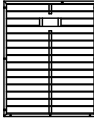
# Components - Parts & Fittings

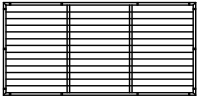
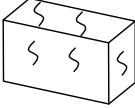
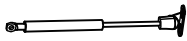
Please check you have all the parts & fittings listed below

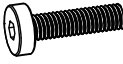
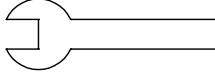
*Note:* The quantities below are the correct amount to complete the assembly. In some cases more fittings may be supplied than are required.

NO	PICTURE	QTY	NO	PICTURE	QTY
A		1	J		3
B1		1	K		34
B2		1	L		31
C		1	M		2
D		1	N		3
E		1	O		1
F		2	P		1
G	 M6*25	2	Q		1
H	 M6*35	26			
I	 M6*50	3			

Blue Diamond Ltd, PO BOX 350, St. Peter Port, Guernsey, GY1 3XA

Website: [www.bluediamond.gg](http://www.bluediamond.gg)

Email: [info@bluediamond.gg](mailto:info@bluediamond.gg)



# Assembly Instructions

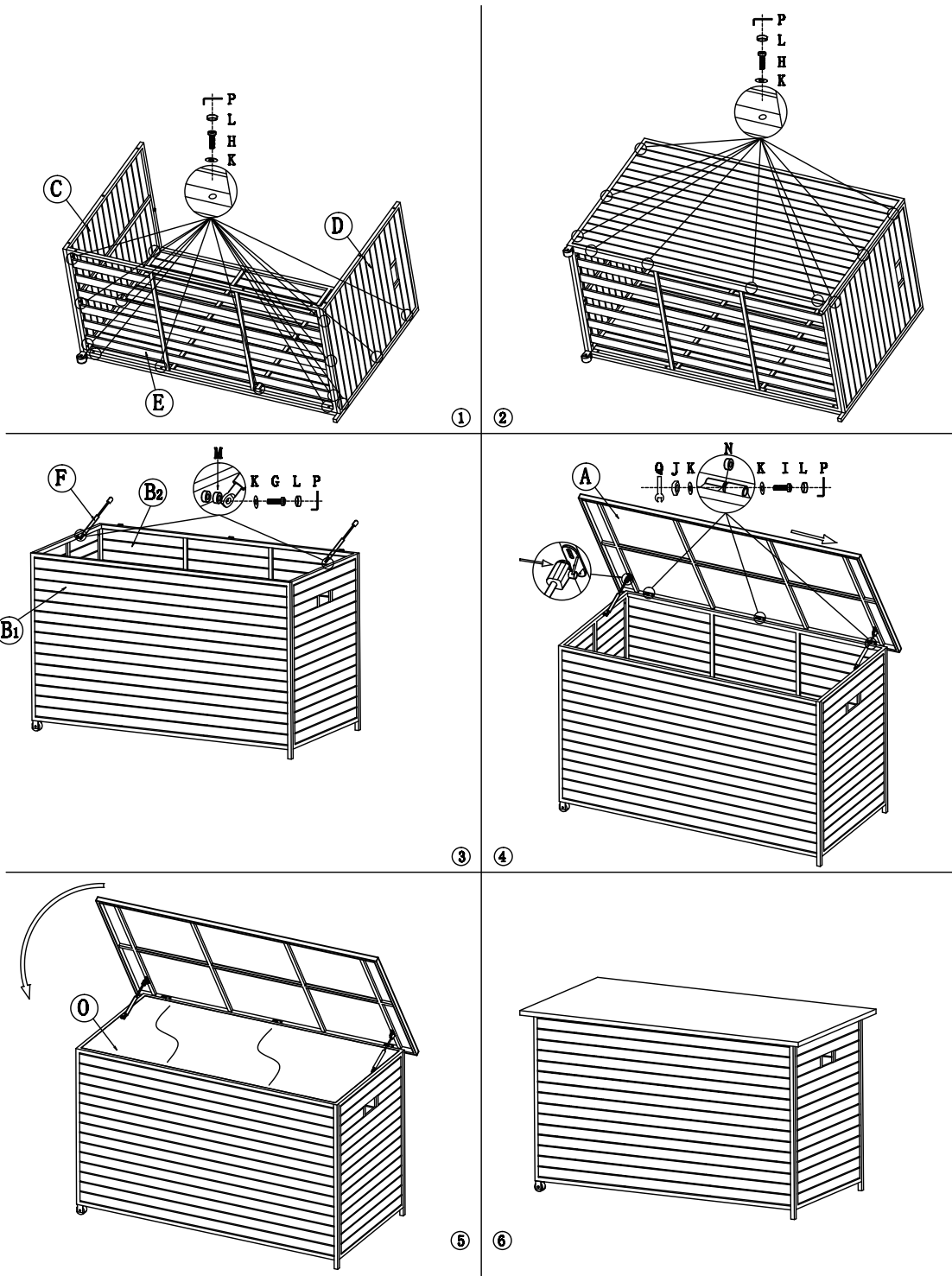

**Important:** Do not fully tighten all screws until assembly is complete.

Blue Diamond Ltd, PO BOX 350, St. Peter Port, Guernsey, GY1 3XA

Website: [www.bluediamond.gg](http://www.bluediamond.gg)

Email: [info@bluediamond.gg](mailto:info@bluediamond.gg)

